

Midi, Mini and Maxi Ringlights

For intense, uniform, and shadow-free illumination for 19 to 53 mm objective diameters.



Mini Ringlight, A08650



4" Ringlight, A08700



8" Ringlight, A08710

Characteristics – Mini Ringlight

- Fit microscope and camera objectives from 19 to 32.5 mm
- Working distance is .5" to 4" (13 to 102)

Characteristics – Midi Ringlight

- Fit microscope and camera objectives from 38 to 53 mm
- Working distance is 1.25" to 3.5" (32 to 89 mm)

Characteristics – Midi and Mini

- Thumbscrew mounting system for precise positioning, ringlights fit directly on most microscope and camera objectives without adapters
- See the accessories section of the catalog for adapters
- Vertical exit bundle option increases work space and prevents the bundle from interfering with surrounding objects

Maxi Ringlights

Characteristics – 4" Ringlight

- Fiber ring diameter is 4.5" (114 mm)
- Working distance ranges from 2" to 8" (51 to 203 mm)
- Light exits at 40 degree angle for specular-free illumination
- Randomized fiber bundle maximizes uniformity

Characteristics – 8" Ringlight

- Low Profile ringlights for working distances from 2.5" to over 4.5 (64 to 114 mm)
- #1/4-20 mounting threads in the coupler (front and top) and the fiber bundle is protected with stainless steel tubing

Mini Ringlights

Part No.	Exit	Working Distance	Polarizer / Analyzer
A08650	Standard	0.5" - 1.5" (13 – 38 mm)	A08632
A08660^	Standard	1.5" - 4" (38 – 102 mm)*	*A22032
A08670^	Vertical	1.5" - 4" (38 – 102 mm)*	A08627
^ 29% more fiber than A08650 ringlight * ESD (Electro Static Discharge) option is available			* Made-to-order products

Midi Ringlights

Part No.	Exit	Working Distance	Polarizer / Analyzer
A08630	Standard	1.25" - 3.5" (32 – 89 mm)*	A08632
A08635	Vertical	1.25" - 3.5" (32 – 89 mm)*	A22032
* ESD (Electro Static Discharge) option is available			

Part No.	ID	OD	Working Distance	Bundle Length	Polarizer / Analyzer
A08700	4" (102 mm)	9.98" (127 mm)	2" - 8" (51 – 203 mm)	30" (762 mm)	A08705
*A08710	7.5" (191 mm)	8.95" (227 mm)	2.5" - 4.5" (64 – 114 mm)	40" (1016 mm)	*A08712
* Made-to-order products					
Use ringlights with our Dichroic color filters, diffusers, and polarizers for alternative lighting effects. Maxi Ringlights will require an adapter, part number A08931, due to the size of the input.					



Specifications

Dimensions in () are in mm

Ringlight Input: Black Anodized Aluminum or Conductive Finish
 Bundle Sheathing: PVC Covered Metal Tubing or Stainless Steel

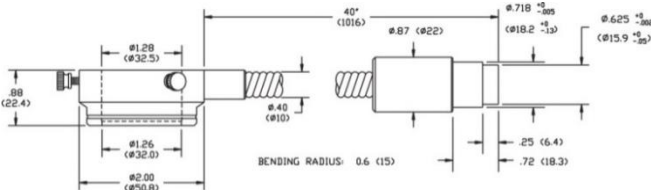

Note:
 A08650 has an active fiber dia. of .22 (5.6) for a working distance of .5 to 1.5" (13 to 38mm).
 A08660 has an active fiber dia. of .25 (6.4) for a working distance of 1.5 to 4" (38 to 102mm).
 Both have F. D. ring dia. of 1.32 (33.5).

A08650 - A08660 -
 19 / 32.5 mm
 Ringlights

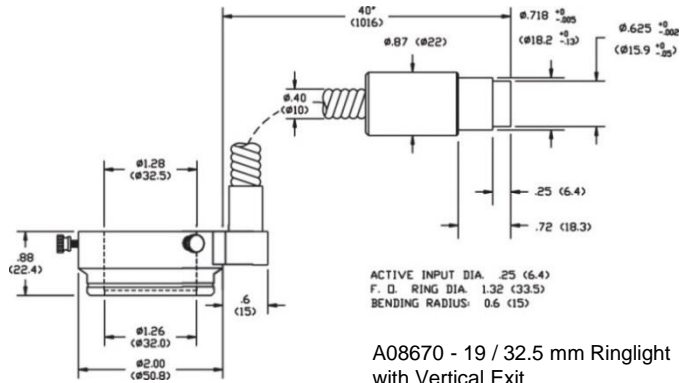

A08670 - 19 / 32.5 mm Ringlight
 with Vertical Exit

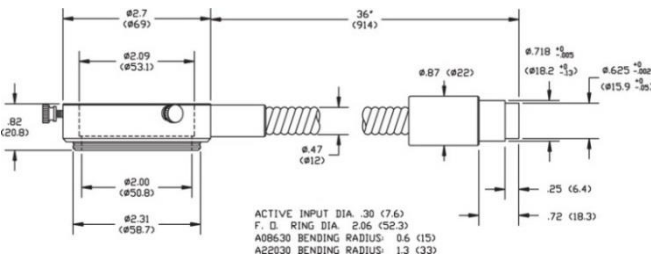

A08630 - 38 / 53 mm
 Ringlight with Standard Exit

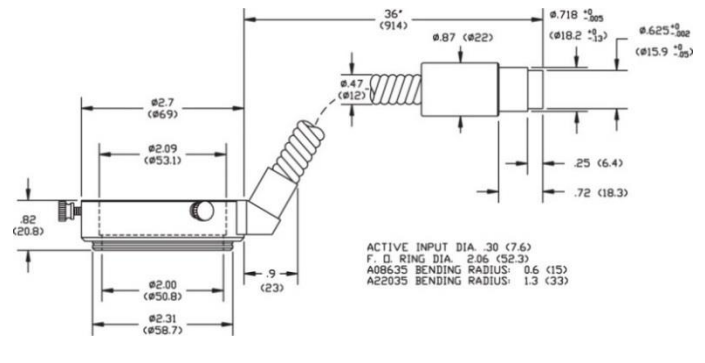

A08635 - 38 / 53 mm Ringlight
 with Vertical Exit

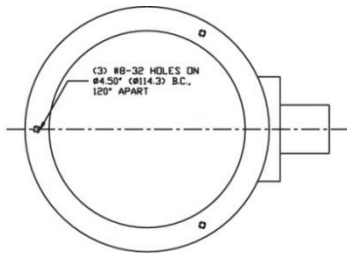

Warning : This product is manufactured with glass fiber. Not for use in cable/hose carrier. Call SCHOTT to discuss moving cable/hose carrier applications.

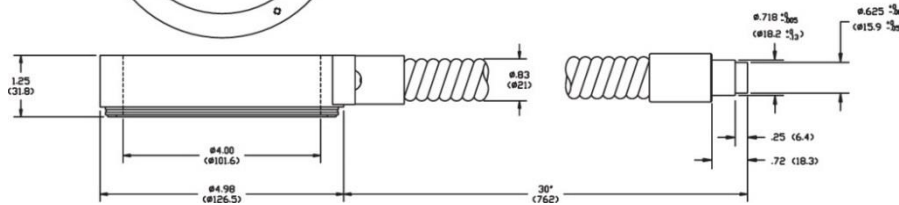

A08700 4" Ringlight

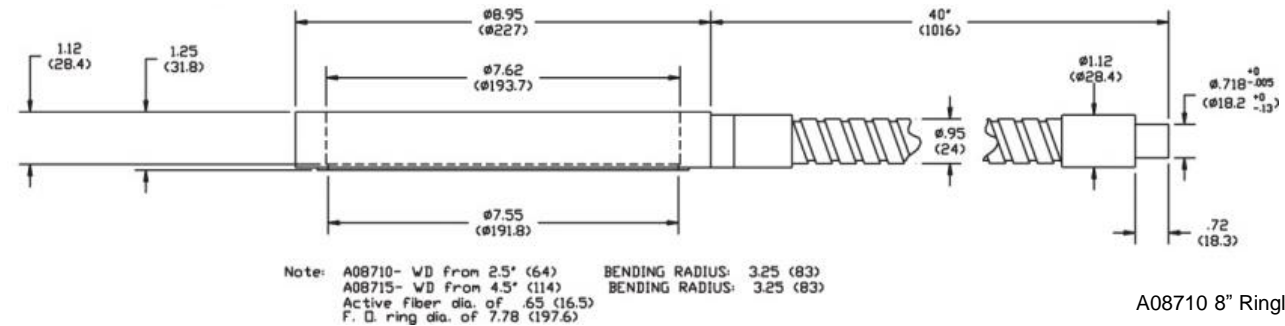

Note: A08710- WD from 2.5" (64) BENDING RADIUS: 3.25 (83)
 A08715- WD from 4.5" (114) BENDING RADIUS: 3.25 (83)
 Active fiber dia. of .65 (16.5)
 F. D. ring dia. of 7.78 (197.6)

A08710 8" Ringlight

