

System diagram ACE[®], MHR[®], DCR[®] III

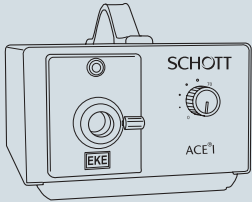

ACE[®] Light Source A20500
01.01.01
 Cost effective light source with maximum lamp life. Excellent for standard microscopy.

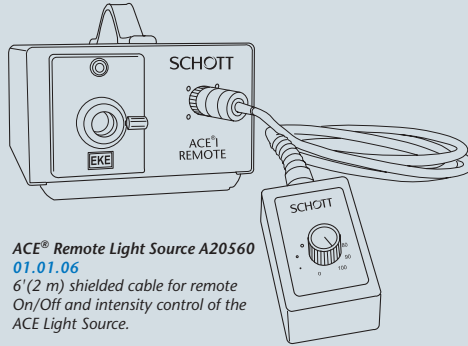

ACE[®] Remote Light Source A20560
01.01.06
 6' (2 m) shielded cable for remote On/Off and intensity control of the ACE Light Source.

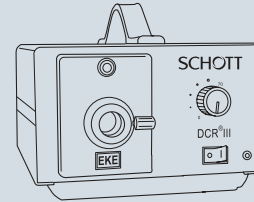

DCR[®] III Light Source A20800
01.10.01
 DC regulated, full featured light source for intense, cool illumination. Excellent for all microscopy & machine vision applications.

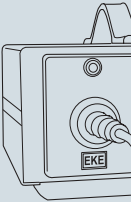

- Universal Ringlights [04.01.01](#)
- Midi and Mini Ringlights [04.02.01](#)
- Ringlights – 60 mm [04.03.01](#)
- Ringlights – 58 mm [04.04.01](#)
- Large Ringlights [04.05.01](#)
- Darkfield Ringlights [04.10.01](#)
- 4 Pt. Darkfield Illuminator [04.15.01](#)

- Ringlight Adapters [04.20.01](#)
- Ringlight Polarizers and Analyzers [04.20.02](#)
- Ringlight Reflector Rings [04.20.03](#)

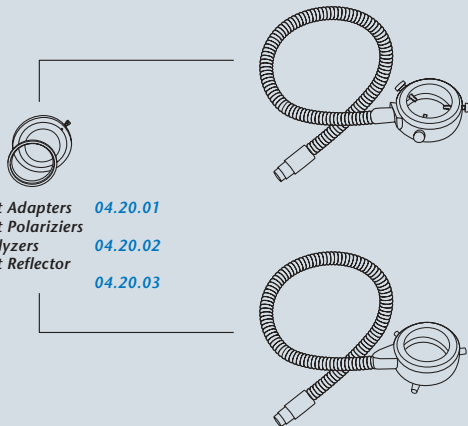

- Single and Dual Backlights [08.01.01](#)
- PANELite[®] Backlights [08.05.01](#)

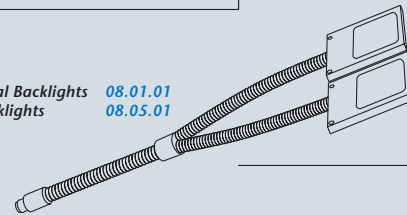

- 1", 2", 3" Lightlines [07.01.01](#)
- Lightlines [07.02.01](#)
- Spatially Randomized Lightlines [07.03.01](#)
- 45° Lightline [07.04.01](#)

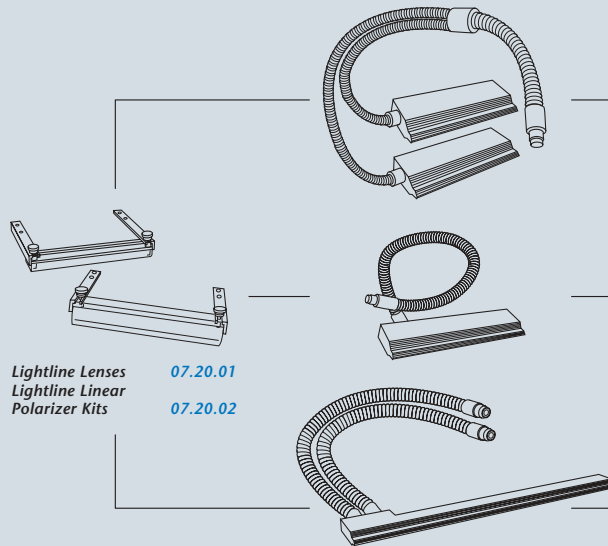

- Lightline Lenses [07.20.01](#)
- Lightline Linear Polarizer Kits [07.20.02](#)

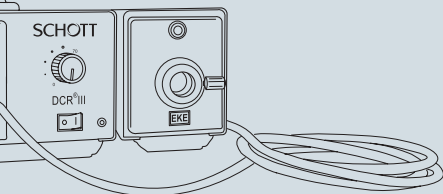

DCR[®] III Remote Light Source Kit A20850 [02.07.01](#)
 Allows remote operation of DCR III[®] lamp head for energy chain and robot arm applications in machine vision

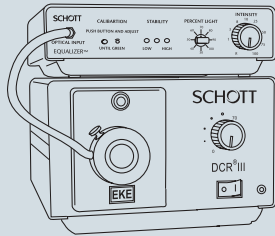

Equalizer[™] Light Feedback Module A20801 [02.06.01](#)
 Provides in combination with the DCR III stabilized light output over time. Designed for the most demanding machine vision applications.

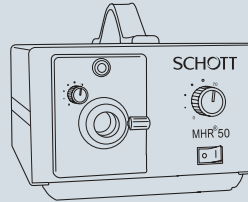

MHR[®]-50 Light Source A20900 [01.10.02](#)
 Regulated metal halide light source for intense, white light with high color temperature. Excellent for demanding microscopy and machine vision applications.



Universal Light Source A20855 [02.07.01](#)
 Cost effective solution for applications where DC power is already available in Machine Vision.

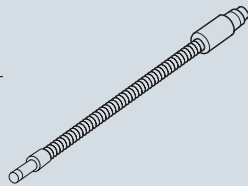

Single Bundles [05.01.01](#)
Dual and Quad Bundles [05.02.01](#)
Randomized and Calibrated Bundles [05.05.01](#)

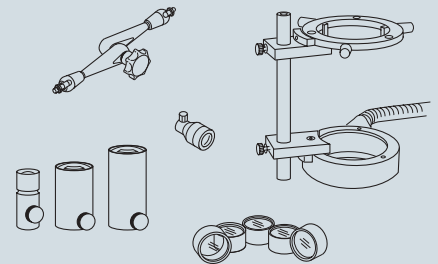
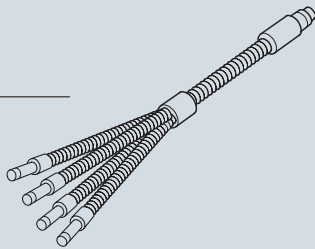

Single and Dual Goosenecks [06.01.01](#)
Combination Goosenecks/Bundles [05.05.01](#)

Filters, Diffusers, Spot Lenses [15.01.01](#)
Bundle Extenders [15.05.01](#)

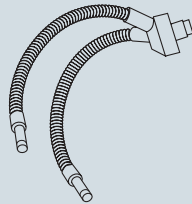

Support Apparatus [16.01.01](#)
Ringlight Support Apparatus [16.01.01](#)
Gooseneck/Bundle Support App. [16.03.01](#)
Lightlines Support App. [16.04.01](#)

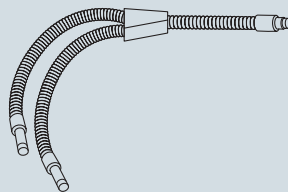

For further details check the [referenced datasheets](#) on SCHOTT's Standard Product Catalog CD-ROM or on SCHOTT's website under www.schott.com/fiberoptics